

A fix for the firmware v. 3.xx problem in Davis Instruments Corp. weather stations

© Torkel M. Jodalen
annoyingdesigns.com

July 1, 2014

Abstract

This document describes how to overcome the “serial line lockdown” introduced by Davis Instruments Corp. in firmware versions 3.00, 3.12 and 3.15 for the *Vantage Pro2* (VP2) series of weather stations and firmware version 3.00 for the *Vue* series of weather stations. The fix is based on the *Atmel AVR ATtinyX5*¹ series microcontroller. The document also provides examples of how Davis Instruments Corp. deals with criticism, user feedback and market communication related to undocumented product updates.

Introduced in 2012, the *green dot* data logger requirement² dramatically changed long-established functionality of these popular weather stations. The unannounced change caused a number of problems for users of original *Davis* equipment, third-party equipment and users relying on access to the console serial line. Unfortunately, Davis Instruments Corp. has repeatedly ignored customer feedback and requests to have the firmware-imposed limitations removed.

This document is an attempt to document the new “original data logger requirement” introduced in firmware versions 3.00 and later, as *Davis* evidently will not comment truthfully on the problems they know this “feature” may cause to end-users.



The unfortunate result of Davis Instruments Corp. product development.

¹*ATtiny25/ATtiny45/ATtiny85*.

²Also known as “the original data logger requirement”.

Disclaimer

The author assumes no responsibility for your use of information contained in this document. Experiment entirely at your own risk.

The author does not represent Davis Instruments Corp. Likewise, the author does not have any commercial interests in Davis Instruments Corp. or any other companies or products mentioned in this document.

All trademarks remain the property of their respective holders, and are used only to identify the products mentioned. Their use in no way indicates any affiliation between the author and the holders of the said trademarks.

No *Davis* products were hurt or damaged beyond repair while these experiments were carried out.

Quoted prices are in USD unless otherwise noted.

Caution

Never connect *anything* to the rear expansion connector of the console while power is still applied to the unit. To safely connect or disconnect *anything*, remove the external power plug and at least one of the batteries — and let the internal capacitor discharge.

Pressing the 2ND button twice to activate the LCD backlight will significantly reduce the time it takes for the capacitor to discharge. The LCD should be completely blank before *anything* is connected to or disconnected from the expansion connector.

DO NOT CONNECT the console serial line directly to a PC or any other equipment not known to use 3.3V signal levels. In most cases a level converter such as the SparkFun FTDI basic breakout, 3.3V version (*SparkFun* product # DEV-09873 @ \$14.95) is required.

Contents

1	Introduction	2
1.1	The <i>Davis Vantage Pro2</i> series	2
1.2	Typical station setup	2
1.3	Original <i>Davis</i> data loggers	3
1.4	Third-party data loggers	4
2	The <i>green dot</i> data logger problem	5
3	A look inside the <i>Davis</i> units	6
3.1	The console serial line	7
3.2	So, how does it work, then?	8
3.3	Demystifying the authentication process	8
3.3.1	An introduction to the Serial Peripheral Interface (SPI)	9
3.3.2	Particulars from the <i>AT45DB011</i> datasheet	10
3.3.3	Logic analyzer findings	11
3.3.4	Having a chat with a <i>green-dot Davis</i> data logger	13
4	The solution (and end to troubles)	16
4.1	The next few steps	17
4.2	Selecting a microcontroller	17
4.3	A simple <i>BASCOM-AVR</i> implementation for the <i>ATtiny25/45/85</i>	18
4.4	A different <i>BASCOM-AVR</i> implementation for the <i>ATtiny85</i>	18
4.5	Using <i>BASCOM-AVR</i> with the <i>STK500</i> and the <i>ATtiny25/45/85</i>	23
4.5.1	The <i>STK500 User Guide</i> — read it!	23
4.5.2	Setup of the <i>STK500</i> for 8-pin devices	23
4.5.3	The MCU programming process	24
4.6	Testing the MCU after programming	25
4.7	Wiring the programmed MCU to the <i>Vantage Pro2</i> console	26
5	Implications and complications	28
5.1	Product names/versions	28
5.2	Design considerations	28
5.3	A need for greed	28
5.4	Email correspondence	29
5.5	Social media	30
6	Et cetera	31
6.1	Parts list	31
6.2	Questions and answers	32
6.3	Contact information	36
	References	37

1 Introduction

1.1 The *Davis Vantage Pro2* series

Despite shortcomings in sensor accuracy³ the *Vantage Pro2* series of weather stations, manufactured by Davis Instrument Corp. of Hayward, CA, USA (from here on referred to as *Davis*) have been popular with weather hobbyists for several years. While neither build quality nor sensor accuracy are the best, there is an abundant range of product add-ons available — not necessarily having a true or perceived value anywhere near the MSRPs, but still useful for self-education, local climate monitoring and carrying out general weather observations. For educational use, the *Davis* series of weather stations often fit the bill nicely (again, somewhat over-priced — but acceptable), allowing students to gain hands-on experience in environmental data collection, data extraction and data analysis.

One of the main advantages of the *Davis VP2* series of weather stations has been the availability of a serial line for access to weather data *without* resorting to expensive add-ons such as the original *Davis* data loggers. In the educational sector, where each dime is counted at least twice before it is spent, this aspect is indeed of great importance — possibly even more important than the somewhat questionable sensor accuracy.

1.2 Typical station setup

A typical *Davis* weather station setup includes the individual outdoor and/or indoor sensors, a connector box commonly referred to as the ISS⁴ — possibly combined with a radio transmitter, depending on station version — and the indoor display unit referred to as *the console*. Several consoles can receive data from one single ISS box.

The console receives data from the ISS, performs some basic calculations, stores min/max values and calculates derived values. Depending on station configuration, it also performs a number of other tasks, including alarm output (sensor readings above or below preset alarm thresholds), acting as a repeater between the ISS and another console, and sending data to an attached data logger for storage/retrieval. The console also processes and replies to commands received via its serial line. These commands are typically issued by software⁵ running on an attached computer — requesting data from the console.

Interestingly, *Davis* documentation [2] states that using the serial line for communication with the outside world "*requires a WeatherLink with Standard Data Logger*". As is now widely known, this statement is *far* from correct.

³Mainly due to low-cost environmental sensors — significant improvements could have been achieved by using only marginally more expensive parts.

⁴Integrated Sensor Suite

⁵*WeatherLink, Weather Display, WOSP*i*, weewx*, etc.

1.3 Original *Davis* data loggers

Data loggers cover two different functions: archiving data from the console *and* providing a means of communicating with the console from a computer.

The data logger itself contains only a very limited amount of logic: it is mainly made up of an *Adesto Technologies DataFlash* chip for data storage and a level converter⁶ used for converting the 3.3V signals from the console's in-system UART⁷ to more commonly accepted signals levels — and the other way around, providing safe 3.3V signal levels to the *ATmega128L* microcontroller (MCU) found on the main printed circuit board (PCB) of the console. Apart from that, the data logger doesn't do much. And even better, it is fully controlled by the *ATmega128L* MCU in the console — the data logger just sits quietly around, doing what it's told to do.

Original *Davis* data loggers are delivered with the *WeatherLink* software, a 1990-ish software product which won't leave a lasting impression with anyone. The RS-232 version of the data logger (product # 06510 SER) has a MSRP of \$165 as listed on the *Davis* website and product catalog [1], somewhat unreasonable for a product made up of the following parts — even after the cost of R&D efforts has been taken into consideration:

- The PCB containing the circuit (internally named *VantageLINK*).
- 2 diodes.
- 3 resistors.
- 8 capacitors.
- 1 *Adesto Technologies AT45DB011 DataFlash* chip.
- The interface unit (RS-232/serial line level converter, USB interface, ...).
The actual interface components are version dependent.
- The 20-pin console connector.
- Exquisite plastic moulding.

Apart from the price tag, another well-known issue with the original *Davis* data loggers is the amount of heat they produce. Poor thermal design causes the internal temperature sensor in the console to over-read when an original data logger is attached to the console, resulting in erroneous indoor temperature readings.

⁶Or other converter, as appropriate for the data logger variant in question.

⁷Universal Asynchronous Receiver/Transmitter.



Figure 1: Original Davis data logger — non-green dot version (product # 06510 SER).



Figure 2: Original Davis data logger, under the cover — green dot version (product # 06510 SER).

1.4 Third-party data loggers

In 2012, third-party data loggers with specifications and functionality equal to the original *Davis* units emerged on the market. Reasonably priced, they offered a most welcome alternative to the overpriced *Davis* units. Even better, the third-party units were the result of a community effort driven forward by dedicated *Davis* customers with a keen interest in electronics and sharing technical knowledge.

Obviously, this development must have caused interesting reactions at the *Davis* HQ in Hayward, CA — perceiving their domain threatened by competitors offering data logger units at significantly lower prices, they took some unfortunate steps to protect their market share.

Mainstream users probably wouldn't even know there are third-party applications and data loggers available, only emphasizing how wasted the *Davis* efforts at establishing a data logger authentication scheme have been.

2 The *green dot* data logger problem

Starting in 2012, new *Davis* data loggers suddenly shipped with a green dot sticker attached to the enclosure, hence the unofficial term *green dot* data loggers. The same green dot sticker started appearing on console enclosures, indicating consoles shipping with the new firmware version 3.00. For the *Vantage Pro2* series of weather stations, the firmware version made a remarkable jump from v. 1.90 to v. 3.00 overnight — and later to version 3.12, the latter also being made available for updating existing consoles running firmware version 1.90.

To cut a long story short: a *green dot* console requires a *green dot* data logger. A *green dot* data logger can be used with a *non-green dot* console, but not the other way around.

The *green dot* data logger requirement effectively puts an end to the use of third-party data loggers with consoles manufactured from mid-2012 onwards. Also, the serial line remains “locked down” until an original *Davis* data logger is attached. In short, this means that:

- It won't be possible to re-use an old (*non-green dot*) data logger with a new *green dot* console.
- If, for some reason, a user has a *non-green dot* console replaced with a new *green dot* console (warranty replacement, etc.), a new data logger may also be required. Customers in the US are only faced with the trouble of getting in touch with *Davis* for a free replacement logger. Customers outside the US are left on their own.
- Anyone using the serial line for direct access to the console will no longer be able to do so. As long as the serial line remains locked down, the console will only output “LCD OK” during the boot sequence. After that, any command issued via the serial line will receive a “NO” reply to indicate that the serial line interface is not available.
- Attaching a *non-green dot* data logger to a *green dot* console will result in the “INCOMPATIBLE LOGGER” message on the console display, as shown on the front page of this document.

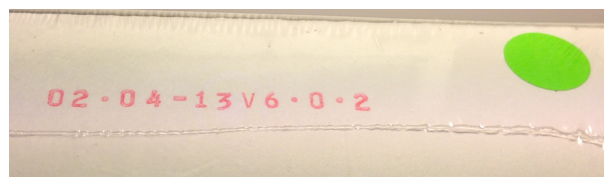

Figure 3: The *green dot* enclosure for new data loggers. The green dot is placed inside the plastic wrapping. All new data loggers are of the *green dot* type, even though they have been shipping without the fancy green sticker lately (2013-). It is not known whether all new data loggers are now shipping with or without the *green dot* sticker.

3 A look inside the *Davis* units

Apart from the custom-made LCD display, the *Davis Vantage Pro2* console consists of commonly available electronics parts. The microcontroller running the entire show is an *Atmel ATmega128L* [5] loaded with *Davis*' own firmware.

The console unit contains a rear expansion connector which is directly wired to the *ATmega128L* MCU. Tracing the individual connectors back to the MCU pinout, as has already been done and documented thoroughly [10], has revealed some interesting facts. Figures 4 and 5 refer.

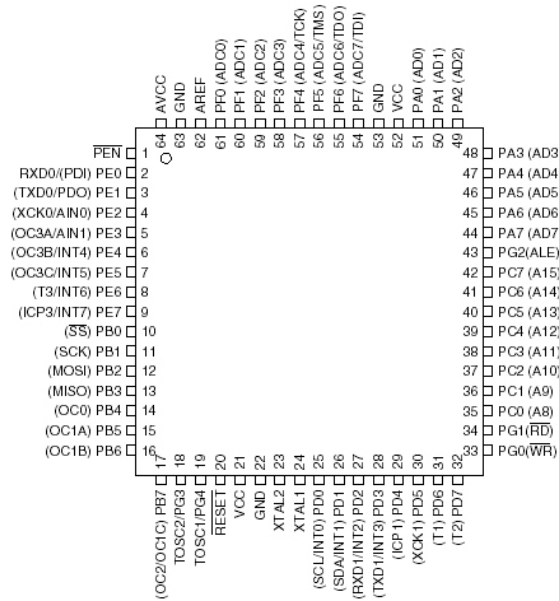

Figure 4: Atmel ATmega128L pinout. Note pins 2-3 (serial data) and 10-13 (SPI).

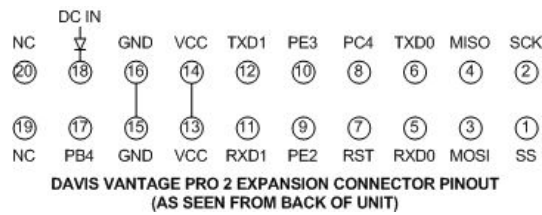

Figure 5: The *Davis Vantage Pro2* rear expansion connector, as described by DeKay [10]. NOTE: Pin numbers/orientation as seen when looking directly at the exposed connector at the rear of the console.

3.1 The console serial line

Of particular interest on the *ATmega128L* MCU are the pins used for serial line communication (pins 2, 3 and GND) as well as the SPI⁸ lines.

Pins 2, 3 and GND are routed directly to the expansion connector at the rear of the console. The signal *logic* adheres to the EIA-232 (RS-232) specification, though signal *levels* are 3.3V only. As such, a level converter is required for interfacing to a personal computer, which would otherwise fry the MCU. A number of small computer systems such as the Raspberry Pi [13] expose a 3.3V serial line, meaning that a direct connection to the serial line on the *Davis* console is possible. A level converter may still be required, refer to the parts list in section 6.1 for details.

The availability of a console serial line is a well-known fact, used by third-party software and peripheral equipment developers. Although official Davis documentation states that a data logger unit is required, it turns out it is not a requirement to access the serial line.

A variety of applications have been developed by users having a desire to add functionality to their consoles: data loggers, interface units, *XBee* and *Bluetooth* modules for wireless data retrieval — just to mention the more common ones. A common denominator is that users want to expand the capabilities of their units, using long-established, well-known and well-documented features offered by their *Vantage Pro2* consoles. This expandability indicates a good *initial* design of the console unit, and it is a shame to see it go only due to poor management decisions at the *Davis* HQ.

⁸Serial Peripheral Interface.

3.2 So, how does it work, then?

During power-up (boot sequence) or after a reset⁹, the console performs internal checks and determines whether a data logger is connected.

For *non-green dot* consoles upgraded to firmware version ≥ 3.12 , the serial line and data logging functions remain available. Users remain free to utilize their third-party data loggers, old-school *Davis* data loggers, direct serial line communication, etc.

The new *green dot* consoles, however, start out on an authentication scheme to ensure that the attached data logger constitutes an original piece of *Davis* equipment. If the authentication fails, the console will display the "INCOMPATIBLE LOGGER" message until it is powered down again.

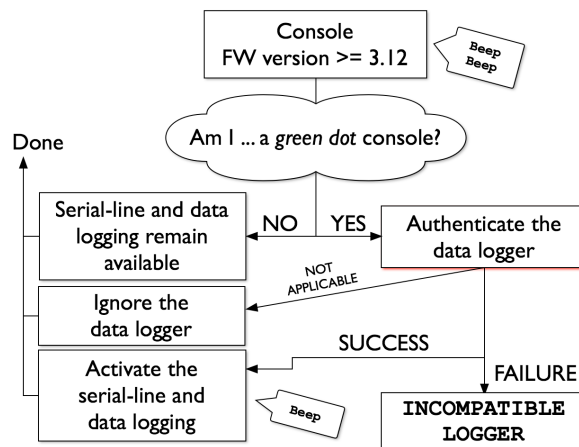

Figure 6: Firmware version ≥ 3.12 data logger authentication. The authentication only takes place if the console itself is identified as a green dot console. Firmware version 3.00 has only been shipped preinstalled on new consoles, whereas version 3.12 can be downloaded to upgrade existing consoles. The "not applicable" branch is followed when the data logger does not return a valid status code.

3.3 Demystifying the authentication process

A qualified attempt at outlining the authentication process can be made by:

- Assuming that no extra hardware has been added to the data logger. To keep unit cost at a minimum, *Davis* equipment does not utilize top-notch environmental sensors. In line with this, assuming that no extra hardware (such as an *Atmel CryptoMemory* chip) has been added to the data logger, as it would increase unit cost — seems like a good place to start.
- Comparing the components found inside the *green dot* and the *non-green dot* data loggers verifies that the above assumption is correct.

⁹By grounding pin 7 (reset) of the expansion connector.

- Watching the serial line for any activity during the boot sequence reveals that the serial line is not involved in the authentication process. This leaves the Serial Peripheral Interface (SPI) as a promising candidate.
- *The Adesto Technologies* datasheet for the *AT45DB011 DataFlash* chip [20] is an interesting read, as it provides several hints of what mechanisms can be employed in the authentication process — without adding additional hardware components to the circuitry.
- Hooking up a logic analyzer such as the *Saleae Logic16* [15] will quickly reveal the communication taking place on the SPI lines during the console boot sequence.
- Hooking up a *BusPirate* [18] and having a chat with the *AT45DB011 DataFlash* chip found in the original data loggers aid in extracting interesting data from the *DataFlash* chips.

3.3.1 An introduction to the Serial Peripheral Interface (SPI)

The Serial Peripheral Interface is used throughout the *Davis* consoles for communication between different subsystems. The SPI lines are also utilized to authenticate an attached data logger during the console boot sequence. Another use is to actually write data to the memory chip in the data logger.

A basic SPI system consists of a *master* unit and one or more *slave* units. At least three wires are required for a basic SPI system consisting of only one master and one slave. For systems consisting of one master unit and multiple slave units, four wires are required. The SPI signal names are as follows:

MOSI Master Out, Slave In — data carrying line.

MISO Master In, Slave Out — data carrying line.

CLK Clock pulse — provided by the master unit.

SS Slave Select (also known as *CS* — Chip Select) — used to “address” one particular slave unit.

Readers unfamiliar with the SPI can find numerous informative articles online. A good starting point is the *Wikipedia* article [23] on the Serial Peripheral Interface. Note that SPI signals are routed “straight through” — *MOSI* from the master should be routed to *MOSI* on the slave, *MISO* from the slave should be routed directly to *MISO* on the master, etc.

In the case of *Davis* consoles, the *ATmega128L* MCU takes the role as master, whereas the *AT45DB011 DataFlash* chip steps into the slave role. That said, the fact that *Davis* resorts to fairly standard communication routines for chip-to-chip communication inside their consoles only aids the process of determining the exact nature of the data logger authentication process.

3.3.2 Particulars from the AT45DB011 datasheet

The *Adesto Technologies AT45DB011 1Mbit DataFlash* chip [20] found in original *Davis* data loggers contains the storage space for logging weather observations from the console.

The *AT45DB011 DataFlash* chip is well documented and it even supports a limited instruction set. The instruction set is typically used to store and retrieve data and to carry our related "housekeeping functions".

Each *DataFlash* chip comes with a unique, factory-programmed 64-byte device identifier which cannot be modified. The chip also has what is known as a programmable 64-byte *security register*. The *security register* can be programmed *once* — once programmed, it *cannot* be changed. The original *Davis* data loggers all come with programmed security registers, in which each of the 64 bytes has been calculated during the "burn in" stage of production.

It is noteworthy that even *non-green dot* data loggers come with programmed security registers in the *AT45DB011 DataFlash* chips. The values in the security registers of the *non-green dot* units are obviously calculated in a way which will not ensure validation of the data loggers when used with *green dot* consoles.

For simplicity, further references to the security register will regard the device identifier (64 bytes) and the actual security register (64 bytes) as one single 128-byte entity.

OpCode	Req'd	Description
0xD7	Yes	Return chip status. Returning 0x8C will do the trick.
0x77	Yes	Return security register, 128 bytes.
0x9F	No	Return manufacturer ID and data density. Values 0x1F and 0x22 identify the <i>AT45DB011 DataFlash</i> chip.

Table 1: Relevant opcodes for the *AT45DB011 DataFlash* chip [20]. The "required" field indicates which opcodes are required for data logger authentication.

Although not required to authenticate an original *Davis* data logger, the 0x9F opcode returns 0x1F (binary 00011111) which identifies *Adesto Technologies* as manufacturer and 0x22 (binary 00100010) which indicates what data density is found on the (1 Mbit) *DataFlash* chip.

3.3.3 Logic analyzer findings

Using a logic analyzer such as the *Saleae Logic16* [15] hooked up to GND and the MOSI, MISO, CLK and SS lines between the console and the original *Davis* data logger reveals which communication is going on there.

The data logger authentication only takes place during the console boot sequence, either when first powering up the console or after a console reset.

The console starts out by reading the chip status. If the chip status is found acceptable, the entire 128-byte security register is read and verified.

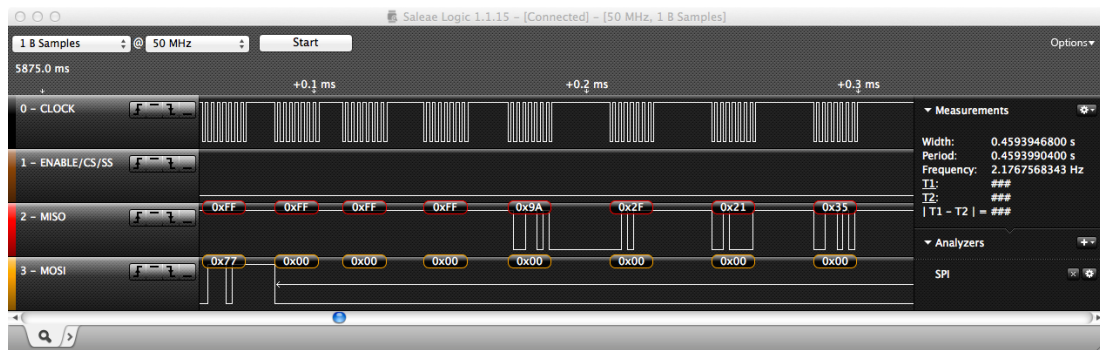

Figure 7: Capturing the SPI communication between the console and the original *Davis* data logger. Here the console issues the `0x77` opcode, followed by three required dummy bytes. The *AT45DB011 DataFlash* chip then replies with the 128 byte values stored in the security register, here starting with `0x9A 0x2F ...`

Recommended configuration settings for the *Saleae Logic16* logic analyser:

- Four channels enabled: MOSI, MISO, CLK and CS/SS.
- Sample rate of 50 MHz (25 MHz also used with success).
- MSB first.
- 8 bits per transfer.
- Clock high when inactive (CPOL = 1).
- Data valid on clock trailing edge (CPHA = 1).
- Enable line active when low.

Connect the MISO, MOSI, CLK, CS/SS and GND probes to the respective signal sources — figure 8 refers.

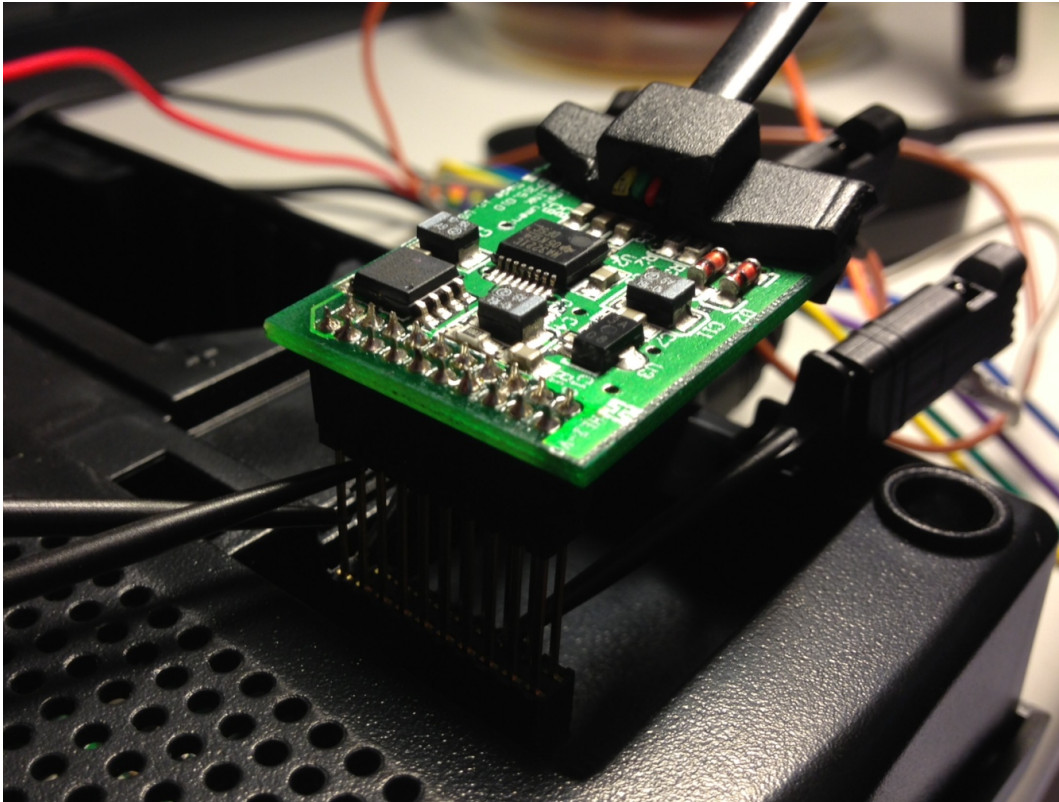

Figure 8: Bird on the wire: the Saleae Logic16 listening in on the SPI communication between the console and the original Davis data logger. The AT45DB011 DataFlash chip is the one at the far left of the PCB.

3.3.4 Having a chat with a *green-dot Davis* data logger

Using a *BusPirate* [18] in SPI mode, the *AT45DB011* status byte and the security register can be read from an original *Davis* data logger. This step is by no means required, but it can be a useful tool to extract the contents of the security register in the *AT45DB011 DataFlash* chip.

The *BusPirate* is connected to a PC via a USB cable. Use a terminal emulator such as *HyperTerminal* (once included in *Microsoft Windows* distributions) or *RealTerm* [9] to communicate with the *BusPirate*. Serial line communication parameters are 115200-8-N-1.

The pins referred to below are numbered as shown in figure 5. Please take note of the "orientation" note just below the figure.

BusPirate Pin name	Original Davis data logger	
	Pin name	Pin #
CS	SS	1
CLK	SCK	2
MOSI	MOSI	3
MISO	MISO	4
3V3 – VPU	VCC	13/14
GND	GND	15/16

Table 2: Wire routing between the *BusPirate* header and the original *Davis* data logger. Also make a connection from 3V3 to the VPU pin, both on the *BusPirate* header (*BusPirate* version 4 users can probably use the "e" command instead — refer to the *BusPirate* documentation [18] for details). Always keep the SPI wires as short as possible.

The *BusPirate* needs to be configured with the correct SPI parameters. Note that the *BusPirate* command interpreter is case-sensitive. These configuration settings have proven to work well, although some of them don't really make any sense (commands listed at left, comments at right):

m	Set mode (entering interactive menu)
5	SPI
1	Speed: 30 kHz
1	Clock polarity: idle when low
2	Output clock edge: active to idle
1	Input sample phase: middle
2	CS: /CS
2	Output type: normal (H=3.3V, L=GND)
W	On-board power supply ON
P	On-board pullup resistors ON

Then proceed by sending some commands to the *AT45DB011 DataFlash* chip in the original data logger and read the return values:

- To read the chip status, which should return `0x8C` :
`[0xd7 r:1]`
- To read the manufacturer ID and device density, which should return the values `0x1F 0x22 0x00 0x00` :
`[0x9f r:4]`
- To read the entire security register of 128 bytes:
`[0x77 0 0 0 r:128]`

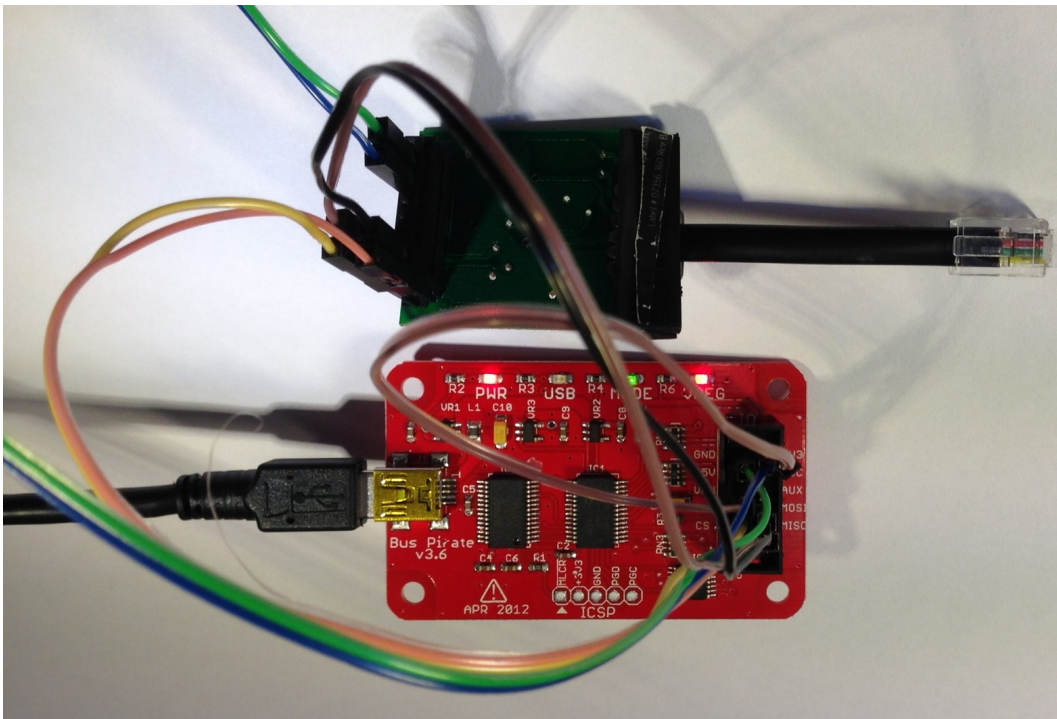

Figure 9: The BusPirate having a friendly chat with an original Davis data logger. NOTE: The SPI wires have to be kept short, otherwise it just won't work.

4 The solution (and end to troubles)

As the data logger authentication process has been reasonably well documented, a flow diagram can be constructed to visualize which details need to be worked on. The essential mechanisms are indicated by red shadows in figure 11. However, please note that:

- For *non-green dot* consoles running firmware version ≥ 3.12 , the authentication process is bypassed. Each console obviously contains firmware-readable information which identifies the execution environment as either *green dot* or *non-green dot*.
- The algorithm employed by *Davis* to derive the 64 bytes of the security register from the 64-byte device ID was identified in late 2013. Section 4.4 refers.
- There are several other *attack vectors* which can be used with success. The below mentioned approach is believed to be the least risky one — with no (or very limited) risk of damaging the console. While other methods have also proved to work, they will not be discussed here.

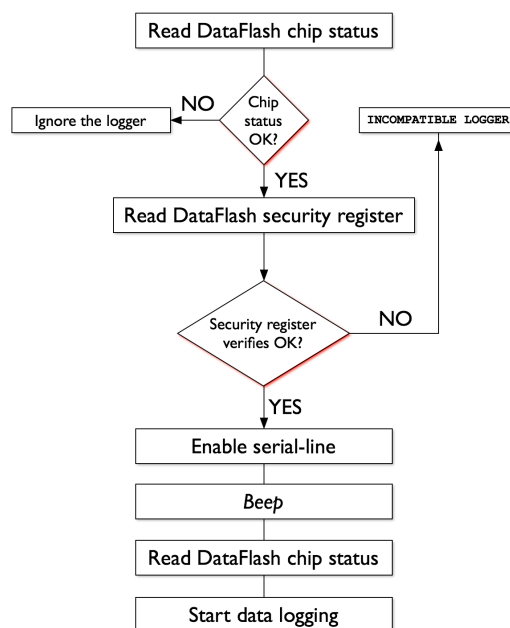

Figure 11: Firmware version $\geq 3.xx$ data logger authentication. The red-shaded boxes identify obvious attack vectors. The "start data logging" step depends on the console settings. Some "page move" opcodes are issued by the console, but the results (or lack thereof) are ignored.

4.1 The next few steps

From here on, it's all a matter of:

- Choosing a microcontroller for the implementation.
- Choosing a compiler/IDE and other programming tools for the implementation.
- Programming the microcontroller.
- Wiring the microcontroller to the console.

4.2 Selecting a microcontroller

There is a huge variety of microcontrollers available, many of which can be used to reply to the commands from the *Davis* console. Of the more interesting ones are the *PIC* family from *Microchip* and the *AVR* series from *Atmel*. While the everlasting *AVR vs. PIC* discussion is better left to others, it's worth noting that:

- *Davis* makes use of the *AVR* family of RISC MCUs — the *ATmega128L* is the "brain" of the *VP2* consoles as well as other *Davis* consoles.
- There are plenty of reasonably-priced programming devices and compilers available for the *AVR* family, including *Arduino*-based programmers.

The fact that an *STK500* programmer [6] was already within reach and that knowledge of the *AVR* platform was already established made it attractive to opt for the *AVR* family of MCUs.

Picking the actual MCU requires studies of the units available. While there are MCUs which come with dedicated SPI pins, such as the *ATmega8*, these units carry the drawbacks of a less attractive form factor, they draw more power and have a higher unit cost than what is really necessary.

MCU name	Farnell.no part #	Newark.com part #	Product ID	Flash memory	Unit price (USD)
ATmega8	9171380	68T3197	ATMEGA8-16PU	8 kB	3.66
ATtiny25	N/A	68T3598	ATTINY25-20PU	2 kB	1.06
ATtiny45	1288352	68T3729	ATTINY45-20PU	4 kB	0.95
ATtiny85	1455162	68T3808	ATTINY85-20PU	8 kB	1.29

Table 3: A selection of relevant *AVR* microcontrollers. Quoted prices as of July, 2013.

The *ATtiny45* [8] is reasonably priced and has plenty of memory for the task at hand. It comes with an *Atmel*-specific Universal Serial Interface (USI), which has to be configured for SPI operation. *Atmel* application note AVR319 [4] refers.

Both the 10 MHz (denoted "-10PU" in the product ID) and the 20 MHz ("-20PU") versions of the *ATtiny25/45/85* have been tested in this project.

4.3 A simple *BASCOM-AVR* implementation for the *ATtiny25/45/85*

The *BASCOM-AVR* BASIC compiler [12] for *Windows* is available free of charge¹⁰. While *Atmel Studio* [7] and *WinAVR* [24] are certainly capable of the task (utilizing the C/C++ languages), *Atmel Studio* requires *Micorosoft Visual Studio* as a back-end, resulting in a rather comprehensive software package.

The *BASCOM-AVR* IDE/compiler requires only some 50 MB of disk space — and runs considerably faster than *Atmel Studio* on old-fashioned computers. While the included *BASCOM-AVR* documentation is comprehensive enough, please note the existence of additional text resources such as [17] and [16].

As it seems, it is only necessary to program a simple¹¹ microcontroller with a program capable of the following tasks:

- Prepare the microcontroller for SPI operation.
- When detecting that the console wants to communicate (*CS/SS* line pulled low):
 - Detect and respond to the *return chip status* command.
 - Detect and respond to the *return security register* command.

This can all be achieved quite easily with the *BASCOM-AVR* compiler. Program listing 1 refers, including a 128-byte security register which was once posted to the *WXForum.net* discussion forum [19].

4.4 A different *BASCOM-AVR* implementation for the *ATtiny85*

The *BASCOM-AVR* program shown in code listing 2 is based on the algorithm described by *WXForum.net* user *watson* [21] in late 2013. The program will provide a random device ID and generate the corresponding security register values. Due to memory (SRAM) requirements, this implementation is not suitable for the *ATtiny25* MCU.

The actual implementation has been successfully tested with an original FW version 3.00 VP2 console and the *ATtiny85* MCU.

¹⁰In the free/demo version, a program size limit of 4 kB applies — consider obtaining a full version license, it's a useful software product which deserves some support.

¹¹"Simple" as in *as simple as possible*, i.e. *at the lowest possible cost*.

```

' Unlock the Davis VP2/Vue console serial line using the ATTtiny25/45/85
' Torkel M. Jodalen <tmj@bitwrap.no> - http://www.annoyingdesigns.com
' Revised: 2013-10-28
'
' NOTE: The SECURITY_REGISTER_DATA (128-byte security register) is
'       defined in the DATA section following the program logic.

$PROG &HFF,&HC1,&HDF,&HFF      ' Lock, FuseLow, FuseHigh, FuseExtended
$REGFILE = "Attiny85.DAT"    ' Change as required for ATTtiny25/45/85

$HWSTACK = 40
$SWSTACK = 16
$FRAMESIZE = 32

Const CMD_STATUS      = &HD7      ' Chip status command
Const CMD_SECURITY    = &H77      ' Dump security register command
Const RESPONSE_STATUS = &H8C      ' Response to CMD_STATUS

Dim I As Byte          ' The infamous loop counter
Dim COMMAND As Byte   ' Command byte as received from console
Dim USI_DATA_READY As Bit ' Status flag

' Slave select / chip select
SS Alias PinB.4        ' Use PINB for READ, PORTB for WRITE
Config PortB.4 = Input ' This will be a READ-ONLY pin, read from "SS"
Set PortB.4           ' Make sure WE don't pull PortB.4 low

' Perform the SPI setup using the ATTtiny's USI
Set USICR.USIWM0      ' SPI mode
Reset USICR.USIWM1    ' SPI mode
Set USICR.USICSR1     ' External clock (clocked by the ATmega128L in the console)
Reset USICR.USICLK    ' External clock
Reset USICR.USICSR0   ' Positive edge
Set USICR.USIOIE      ' Enable counter overflow interrupt

' Enable USI overflow interrupts
On USI_OVF USI_OVERFLOW_INT
Enable USI_OVF
Enable Interrupts

Do
  While SS = 1
    ' Wait for SS low
  Wend

  ' Set up the ATTtiny25/45/85 USI for SPI operation (SS has been pulled low)
  Config PortB.0 = Input ' PB0 = MOSI
  Config PortB.1 = Output ' PB1 = MISO
  Config PortB.2 = Input ' PB2 = Clock

  ' Wait for something to come around
  While USI_DATA_READY <> 1
  Wend

  If COMMAND = CMD_STATUS Then
    ' Respond to CMD_STATUS
    While USI_DATA_READY <> 1
    Wend
    USIDR = RESPONSE_STATUS
    Reset USI_DATA_READY
  End If
End Do

' NOTE: Code listing continued on next page!

```

Listing 1: Complete BASCOM-AVR source code listing for the Atmel ATTtiny25/45/85. Change the \$REGFILE assignment to indicate the ATTtiny model being used (here: ATTtiny85).

```

Elseif COMMAND = CMD_SECURITY Then
  ' Respond to CMD_SECURITY
  For I = 0 To 2
    ' First respond with three dummy bytes as per AT45DB011 specification
    While USI_DATA_READY <> 1
      Wend
      USIDR = &H00
      Reset USI_DATA_READY
    Next I
  For I = 0 To 127
    ' Then respond with 128-byte security register data
    While USI_DATA_READY <> 1
      Wend
      USIDR = Lookup(I , SECURITY_REGISTER_DATA)
      Reset USI_DATA_READY
    Next I
  End If

  ' Done communicating, set Hi-Z state on PBI (MISO) port
  Config PortB.1 = Input

Loop
End

' The interrupt routine
USI_OVERFLOW_INT:
  Set USI_DATA_READY      ' Indicate data received & ready
  COMMAND = USIDR         ' Get one byte from the SPI line
  USISR = &B01_000000    ' Reset status register
Return

' Security register data - 128 bytes of known/accepted values
SECURITY_REGISTER_DATA:
Data &H80, &H2D, &H22, &H6F, &H52, &H6F, &H98, &HA9, &H21, &H25, &H5E, &H2D, &H2D, &H31, &HD2, &H39, _
&H18, &H1C, &H63, &H0C, &H31, &H21, &H2D, &H39, &H90, &HDE, &H94, &H6F, &H6B, &H77, &H73, &H7F, _
&H63, &H8C, &H88, &H84, &H80, &H9C, &H98, &H94, &H90, &HAD, &HA9, &HA5, &HA1, &HBD, &HB9, &HB5, _
&HB1, &HCA, &HCE, &HC2, &HC6, &HDA, &HDE, &HD2, &HD6, &HEB, &HEF, &HE3, &HE7, &HFB, &HFF, &HF3, _
&H0B, &H02, &H16, &H17, &H11, &H15, &H1F, &H22, &H00, &H00, &H46, &H00, &HFF, &HFF, &HAC, &HFF, _
&H30, &H30, &H4D, &H32, &H36, &H39, &H37, &H31, &H0F, &H1C, &H0C, &HFF, &HFF, &HFF, &HFF, &HFF, _
&H3F, &HFF, &HFF, &HFF, &HFF, &HFF, &HFF, &HFF, &HFF, &HFF, &HFF, &HFF, &HFF, &HFF, &HFF, _
&HFF, &HFF, &HFF, &HFF, &HFF, &HFF, &HFF, &HFF, &HFF, &HFF, &HFF, &HFF, &HFF, &HFF, &HFF, _

```

Listing 1: Code listing continued from previous page.

```

' Unlock the Davis VP2/Vue console serial line using the ATtiny85 and a
' random device ID. Using algorithm as described by WXForum.net user
' "watson" on November 28, 2013.
'
' NOTE: The ATtiny25 does NOT have sufficient SRAM for this implementation.
'
' Torkel M. Jodalen <tmj@bitwrap.no> - http://www.annoyingdesigns.com
' Revised: 2013-11-30

SPROG &HFF,&HC1,&HDF,&HFF      ' Lock, FuseLow, FuseHigh, FuseExtended
SREGFILE = "Attiny85.DAT"

$HWSTACK = 64
$SWSTACK = 16
$FRAMESIZE = 32

Config BASE = 0

Const CMD_STATUS      = &HD7      ' Chip status command
Const CMD_SECURITY    = &H77      ' Dump security register command
Const CMD_DEVICEID    = &H9F      ' Manufacturer & Device ID command
Const RESPONSE_STATUS = &H8C      ' Response to CMD_STATUS

Dim Response(128) As Byte          ' Will contain 128-byte reply to CMD_SECURITY command
Dim I As Byte                     ' The infamous loop counter
Dim COMMAND As Byte              ' Command byte as received from console
Dim USI_DATA_READY As Bit        ' Status flag

Declare Function Calculate(ByteNo As Byte) As Byte

' Fill in a random device ID, bytes 64-127
For I = 64 To 127
    Response(I) = RND(256)
Next I
' Fill in appropriate security register values, bytes 3-63
For I = 3 To 63
    Response(I) = Calculate(I)
Next I
' Fill in a serial number(?), bytes 0-2
Response(0) = &H9A      ' 9A 2F 21 are values found in an original
Response(1) = &H2F      ' logger. This may or may not be a device
Response(2) = &H21      ' serial number. Doesn't seem to matter.

' Slave select / chip select
SS Alias PinB.4         ' Use PINB for READ, PORTB for WRITE
Config PortB.4 = Input  ' This will be a READ-ONLY pin, read from "SS"
Set PortB.4

' Perform the SPI setup
Set USICR.USIWM0      ' SPI mode
Reset USICR.USIWM1    ' SPI mode
Set USICR.USICCS1     ' External clock (clocked by the ATmega128 in the console)
Reset USICR.USICLK    ' External clock
Reset USICR.USICCS0   ' Positive edge
Set USICR.USIOIE      ' Enable counter overflow interrupt

' Enable USI overflow interrupts
On USI_OVF USI_OVERFLOW_INT
Enable USI_OVF
Enable Interrupts

Do
    While SS = 1
        ' Wait for SS low
    Wend

    ' Set up the ATtiny85 USI for SPI operation (SS has been pulled low)
    Config PortB.0 = Input      ' PB0 = MOSI
    Config PortB.1 = Output     ' PB1 = MISO
    Config PortB.2 = Input      ' PB2 = Clock

' NOTE: Code listing continued on next page!

```

Listing 2: Complete BASCOM-AVR source code listing for the Atmel ATtiny85 resulting in a random device ID and corresponding security register values.

```

' Wait for something to come around
While USI_Data_ready <> 1
Wend

If COMMAND = CMD_STATUS Then
' Respond to CMD_STATUS
While USI_DATA_READY <> 1
Wend
USIDR = RESPONSE_STATUS
Reset USI_DATA_READY

ElseIf COMMAND = CMD_SECURITY Then
' Respond to CMD_SECURITY
For I = 0 To 2
' First respond with three dummy bytes as per AT45DB011D specification
While USI_DATA_READY <> 1
Wend
USIDR = &H00
Reset USI_DATA_READY
Next I
For I = 0 To 127
' Then respond with 128-byte security register data
While USI_DATA_READY <> 1
Wend
USIDR = Response(I)
Reset USI_DATA_READY
Next I
End If

' Done communicating, set Hi-Z state on PBI (MISO) port
Config PortB.1 = Input

Loop
End

' The interrupt routine
USI_OVERFLOW_INT:
Set USI_DATA_READY
COMMAND = USIDR
USISR = &B01_000000
Return

Function Calculate(ByteNo As Byte) As Byte
' Not too elegant --- BASCOM-AVR only accepts one operation per assignment
Local Index As Byte
Index = ByteNo + 64 ' 64-127 for device ID
Index = Response(Index) + ByteNo ' Index in DAVIS_DATA matrix
Index = Index MOD 256 ' Avoid index out of range
Response(ByteNo) = LookUp(Index, DAVIS_DATA)
End Function

' Lookup table as described by WXForum.net user "watson"
DAVIS_DATA:
$DATA
Data &H00, &H04, &H08, &H0C, &H10, &H14, &H18, &H1C, &H21, &H25, &H29, &H2D, &H31, &H35, &H39, &H3D
Data &H46, &H42, &H4E, &H4A, &H56, &H52, &H5E, &H5A, &H67, &H63, &H6F, &H6B, &H77, &H73, &H7F, &H7B
Data &H8C, &H88, &H84, &H80, &H9C, &H98, &H94, &H90, &HAD, &HA9, &HA5, &HA1, &HBD, &HB9, &HB5, &HB1
Data &HCA, &HCE, &HC2, &HC6, &HDA, &HDE, &HD2, &HD6, &HEB, &HEF, &HE3, &HE7, &HFB, &HFF, &HF3, &HF7
Data &H18, &H1C, &H10, &H14, &H08, &H0C, &H00, &H04, &H39, &H3D, &H31, &H35, &H29, &H2D, &H21, &H25
Data &H5E, &H5A, &H56, &H52, &H4E, &H4A, &H46, &H42, &H7F, &H7B, &H77, &H73, &H6F, &H6B, &H67, &H63
Data &H94, &H90, &H9C, &H98, &H84, &H80, &H8C, &H88, &HB5, &HB1, &HBD, &HB9, &HAS, &HA1, &HAD, &HA9
Data &HD2, &HD6, &HDA, &HDE, &HC2, &HC6, &HCA, &HCE, &HF3, &HF7, &HFB, &HEF, &HE3, &HE7, &HEB, &HEF
Data &H31, &H35, &H39, &H3D, &H21, &H25, &H29, &H2D, &H10, &H14, &H18, &H1C, &H00, &H04, &H08, &H0C
Data &H77, &H73, &H7F, &H7B, &H67, &H63, &H6F, &H6B, &H56, &H52, &H5E, &H5A, &H46, &H42, &H4E, &H4A
Data &HBD, &HB9, &HB5, &HB1, &HAD, &HA9, &HA5, &HA1, &H9C, &H98, &H94, &H90, &H8C, &H88, &H84, &H80
Data &HFB, &HFF, &HF3, &HF7, &HEB, &HEF, &HE3, &HE7, &HDA, &HDE, &HD2, &HD6, &HCA, &HCE, &HC2, &HC6
Data &H29, &H2D, &H21, &H25, &H39, &H3D, &H31, &H35, &H08, &H0C, &H00, &H04, &H18, &H1C, &H10, &H14
Data &H6F, &H6B, &H67, &H63, &H7F, &H7B, &H77, &H73, &H4E, &H4A, &H46, &H42, &H5E, &H5A, &H56, &H52
Data &HA5, &HA1, &HAD, &HA9, &HB5, &HB1, &HBD, &HB9, &H84, &H80, &H8C, &H88, &H94, &H90, &H9C, &H98
Data &HE3, &HE7, &HEB, &HEF, &HF3, &HF7, &HFB, &HFF, &HC2, &HC6, &HCA, &HCE, &HD2, &HD6, &HDA, &HDE

```

Listing 2: Code listing continued from previous page.

4.5 Using *BASCOM-AVR* with the *STK500* and the *ATtiny25/45/85*

Getting up to speed with *BASCOM-AVR* and the *STK500* may require a tiny bit of effort. The main challenge will probably be the installation of the required *Windows* drivers for the *STK500*. The steps below should be sufficient to get going within an hour or so:

4.5.1 The *STK500 User Guide* — read it!

Take the time to read the *STK500 User Guide* [3]. The *STK500* is a fine piece of equipment with a large number of configuration options. Don't waste your time on experimenting with the programmer — *read the instructions* and get up to speed with the *STK500 User Guide* taking you step by step through the process, including how to get the *Windows* drivers properly installed.

4.5.2 Setup of the *STK500* for 8-pin devices

The somewhat dated *STK500 User Guide* does not even list the *ATtiny25/45/85* MCUs among the units it is capable of programming. It is still capable of programming these units without further ado — but please note the following excerpt from the *ISP Programming* section, which applies when programming the *ATtiny25/45/85* MCUs:

When programming 8-pin devices, note the following: Pin 1 is used both as RESET and as PB5 on some devices (*ATtiny11*, *ATtiny12* and *ATtiny15*). Pin 1 on the 8-pin sockets *SCKT3400D1* and *SCKT3400D1* are connected to PB5. The RESET signal used during ISP programming is therefore not connected to pin 1 on these sockets. This signal must be connected by placing a wire between RST and the *PORTE* header and PB5 on the *PORTB* header.

Figure 12 shows the required *PORTE/RST* and *PORTB/PB5* interconnection, whereas figure 13 shows the proper jumper settings.

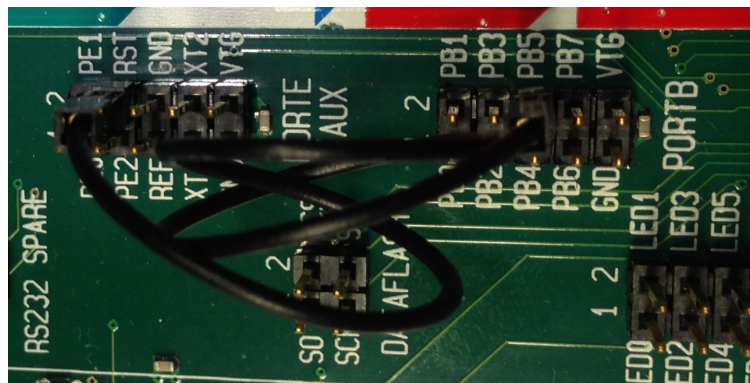

Figure 12: The *PORTE/RST* and *PORTB/PB5* interconnection required for programming the 8-pin *ATtiny25/45/85* MCUs.

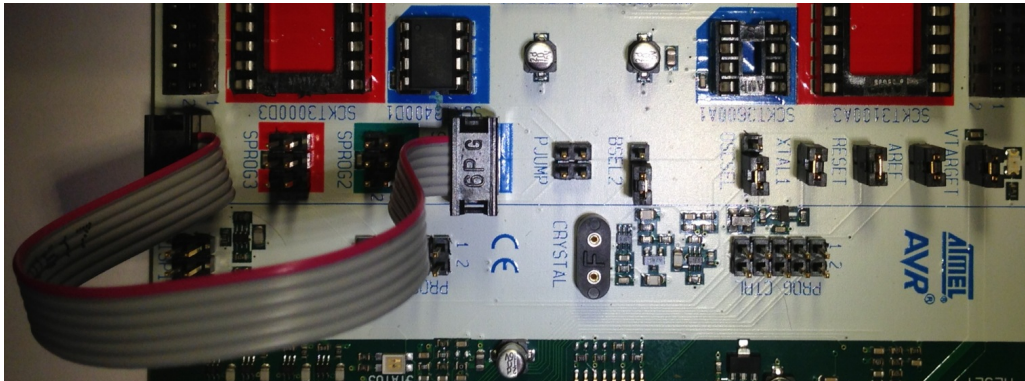

Figure 13: Jumper configuration for the STK500. Also note the location of the ATtiny25/45/85 MCU as placed in the programming socket. In this photo, the "orientation notch" of the MCU points upwards.

4.5.3 The MCU programming process

Using the *BASCOM-AVR* compiler and the *STK500* programmer is more or less self-explanatory. The *STK500* should be connected to a PC via a serial line and then provided with appropriate DC power (polarity doesn't matter, but it's a good practice to keep *ground* exposed and the positive voltage at the center pin of the connector). Then insert the *ATtiny25/45/85* MCU into the programming socket and switch on the *STK500*.

After compiling the program and receiving the *No errors* message in the *BASCOM-AVR* status line, simply transfer the compiled program to the MCU by pressing <F4> to bring up the *programming window* and click the *program chip* icon. The programming window will close when the operation has been completed without errors.

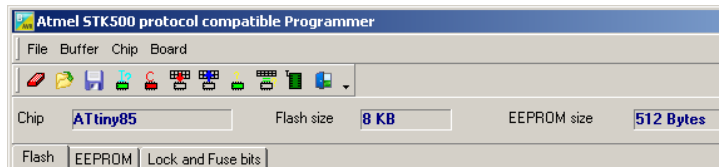

Figure 14: The *BASCOM-AVR* programmer all set for working with an *ATtiny85* MCU.

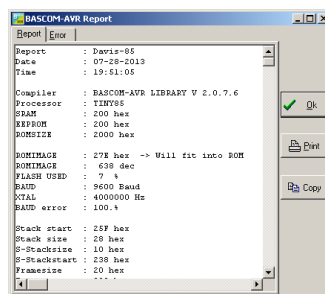

Figure 15: The *BASCOM-AVR* programming results/status report (CTRL-W keyboard shortcut).

4.6 Testing the MCU after programming

Once the MCU has been programmed in the *STK500* programmer, it can be tested by using the *BusPirate* without removing the MCU from the *STK500*. Keep the wires as short as possible and remember to disconnect the programming cable from the blue SPROG1 header. Even here the combined length of the PCB "wires" and the wires connecting the *BusPirate* to the *STK500* may be too long to facilitate trouble-free SPI communication. In that case, simply remove the MCU from the *STK500* programmer and connect it directly to the *BusPirate*.

The *BusPirate* settings to be applied are `m5121112` (refer to section 3.3.4 for details).

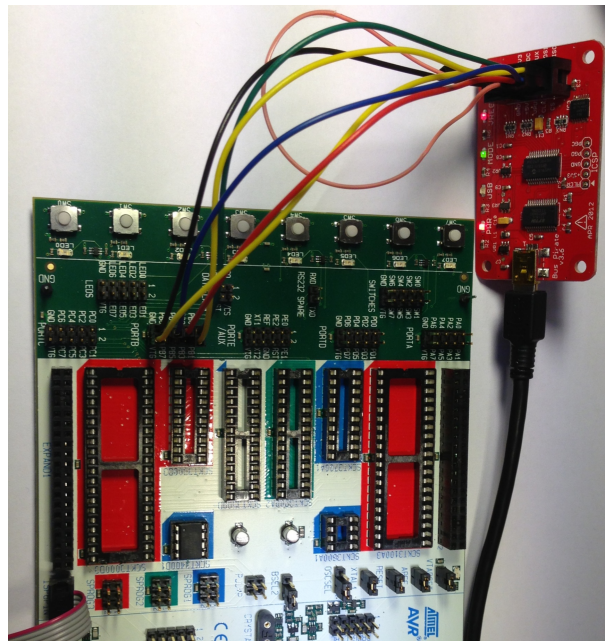

Figure 16: In this setup, the ATtiny25 is powered from the BusPirate. The STK500 power switch should remain in the OFF position. Other test setups are also possible.

BusPirate pin name	STK500 PORTB pin name	ATtinyX5 pin (signal name)
MOSI	PB0	PB0 (MOSI)
MISO	PB1	PB1 (MISO)
CLK	PB2	PB2 (SCK)
CS	PB4	PB4 (CS/SS)
3V3	VTG	VCC
GND	GND	GND

Table 4: Wiring diagram for connections between the BusPirate and the STK500 PORTB for testing the programmed MCU. Also refer to table 2 for information regarding the required BusPirate 3V3/VPU interconnection.

4.7 Wiring the programmed MCU to the *Vantage Pro2* console

Wiring the *ATtiny25/45/85* to the console can be achieved by connecting 6 *short* wires from the console expansion connector to the MCU. As SPI communication is intended for short-distance communication only (typically between devices located on the very same PCB), using long wires will *not* work. The implementation shown here has been successfully tested with 10-15 cm wire lengths.

For friendly handling and easy removal¹² of the MCU, it may be a good idea to use a *DIL-8 socket* with 2.54mm pin spacing such as the *TE Connectivity 1-390261-2* (*Farnell* part # 1101345, *Newark* part # 52K3276). Soldering wires to the socket before inserting the MCU will prevent damage to the MCU from the heat applied during soldering. Also take note of the notch in the socket — there should be a visual “this side up”-indication so that the MCU can be correctly oriented.

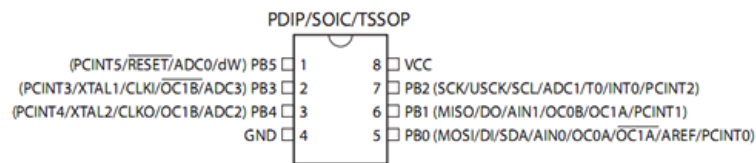

Figure 17: The *ATtiny25/45/85* (DIP8 package [22]). Notice the notch at the “top” of the chip — the only visible “this side up”-mark found on this creature.

Refer to table 5 and figure 18 for details regarding the wiring between the VP2 expansion connector and the *ATtiny25/45/85* MCU.

ATtiny pin #	ATtiny pin/signal name	Signal name	VP2 pin #
3	PB4	CS/SS	1
4	GND	GND	15 or 16
5	PB0 / MOSI	MOSI	3
6	PB1 / MISO	MISO	4
7	PB2 / SCK	CLK	2
8	VCC	VCC	13 or 14

Table 5: Wiring diagram for connections between the *ATtiny25/45/85* MCU and the VP2 console. NEVER short the GND and VCC lines.

¹²You never know when you’ll need to reprogram it.

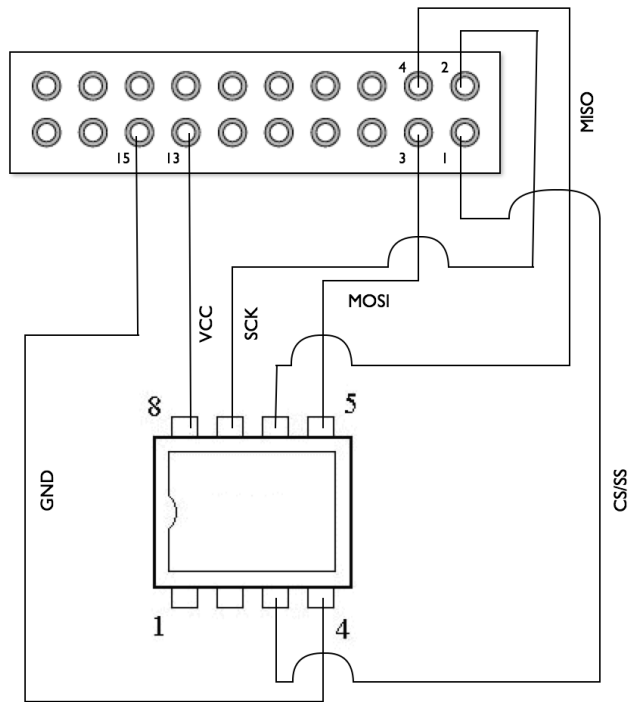

Figure 18: Required wiring between the console expansion connector and the MCU. Refer to figure 5 for a description of the expansion connector.

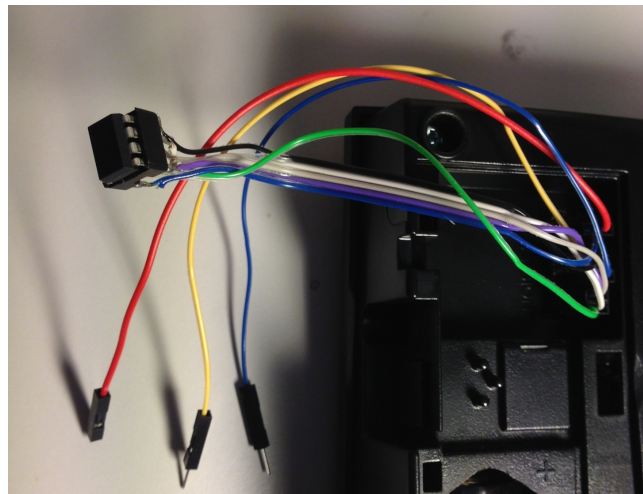

Figure 19: Presto! The three extra wires carry the serial line signals TXD, RXD and GND at 3.3V signal levels. Using shorter wires, the ATtiny25/45/85 MCU can be safely tucked away in the small bay just below the console expansion connector. The length of the serial line wires is not critical — wire lengths of more than 1m have been used without any signs of trouble. Regarding serial line voltage levels, please note the caution on page 2 of this document.

5 Implications and complications

Davis created a number of problems by introducing firmware version 3.xx — not only to those utilizing non-*Davis* equipment, but also to their own support organization. Also, answers received from *Davis* technical support don't really add to the company's credibility. Section 5.4 contains some relevant email excerpts.

5.1 Product names/versions

- *Davis* has released no official information on the "original data logger" requirement introduced in firmware version 3.00.
- *Davis* will replace *non-green dot* data loggers with *green dot* data loggers for free — for customers within the US. Customers elsewhere are left on their own.
- *Davis* keeps receiving negative customer feedback from users being forced to replace their original *Davis* data loggers after warranty replacements, station refurbishing, etc.
- There is no change in the product number to distinguish a *green dot* console from a *non-green dot* console. Ditto for the original data loggers. Although there is a change in the console *manufacturing code*, that's not what users look for when ordering replacement units. A *Vantage Pro2* should forever remain a *Vantage Pro2*. A product carrying the same name is expected to share the same specifications and functionality between individual units of the same kind *unless* the manufacturer makes it *very clear* that there exists different versions of the same product.

5.2 Design considerations

- It's indeed tempting to ask ... why wasn't a level converter included in the *Vantage Pro2* console design? It would only add some \$2 to the overall unit cost and users would love to be able to extract their very own weather data without spending another \$165 on a data logger.
- Why such a poor thermal design of the original data loggers, which greatly influence indoor temperature readings?

5.3 A need for greed

- After an informal lunch near Hayward, CA in May 2013 the author learned that the "original data logger" requirement isn't too popular within the *Davis* organization. Oh, dear. There is more than one example that when a technology company listens more to the beancounters than to the engineering staff, the beginning of the end is near.

- The official *Davis* policy of “smokescreen lies” may work for a short while — until someone takes the trouble to document what really goes on. Sadly, there is only room for one character at the bottom line — it all boils down to \$.

5.4 Email correspondence

In late December, 2012, the following email exchanges took place between the author and *Davis* technical support. At this point the nature of the “original data logger requirement” had already been identified.

```
>I've been made aware of a recent design change to the Vantage  
>Pro2 console, related to the use of the expansion connector at  
>the rear of the unit. Specifically, there are talks of  
>"firmware version 3" which prohibits use of non-Davis data  
>loggers, etc. Is this correct? If so, why?
```

The latest firmware version 3.0 supports the latest display console hardware for the Vantage Pro2 and Vantage Vue. We have updated the hardware on the consoles which requires version 3 firmware. We don't support non-Davis data loggers so I wouldn't be able to tell you if a non-Davis data logger would work.

Apparently, the hardware in the consoles has been updated. That's an interesting statement, as both high-resolution x-ray scans¹³ and inspection of the individual components of *green dot* and *non-green dot* consoles reveal ... very little change. Even *if* there had been a significant hardware change, the *ATmega128L* remains the same — there is definitely no *requirement* to lock down the serial line, which remains capable of saying “NO” — only confirming that it's still able to receive and send data. Surprisingly, the “why” question was never answered or commented upon.

You need a current data logger to work with current consoles. We never supported communicating without a data logger. If you were able to do this at 1.90 but not at 3.0 it is a byproduct of the hardware, not by design.

Oh, come on. There is absolutely no need for a data logger — and you know that! You may not *support* it or even *like* it, but don't blame the hardware. It's all *Davis* firmware running the show, and you know just too well what you have done to cripple the new *green dot* consoles. Now the world also knows.

You always did need to use a data logger to communicate with the station, this is nothing new.

¹³Unfortunately, these scans were made available for “inspect and destroy” use only — in a strictly controlled environment. Images would otherwise have been included here.

Someone is telling lies here. The above statement just isn't true, refer to [10] and [14] for details.

The hardware has been updated for greater reliability and to provide for future enhancements.

Asking for further details, this was swiftly followed up by:

There are no known reliability issues with 1.90, we are always updating the design and hardware on our stations to keep up with current technology. At this point there are no plans for future enhancements to our stations.

Remarkably, within a 24-hour period *Davis* states that the consoles have been updated for greater reliability — without actually being aware of any reliability issues in the "old" versions. That sounds like an interesting way to spend an R&D budget. Also, providing for future enhancements which are not even planned certainly leaves an impression that something is seriously wrong with either the engineering teams or the technical support teams — or possibly both — at the *Davis* HQ.

As for the "we always update" statement, it's worth noting that firmware version 1.90 was released in 2009, with no public updates until version 3.00 started shipping on new consoles in mid/late 2012. The meaning of the word "always" seems to be somewhat stretched, twisted and redefined.

5.5 Social media

Davis maintain their own *Facebook* page, mainly allowing customers to praise their original *Davis* products.

Interestingly, any "wall post" with even a hint of criticism is removed immediately. Even more interesting is the fact that users who *dare* to ask critical but appropriate questions are *banned* from further posting. Indeed a most interesting policy for a company which *loves customer feedback* (as stated on the *Davis* website).

It seems that someone could easily get a job in the public relations office of the *Democratic People's Republic of Korea*.

6 Et cetera

6.1 Parts list

Apart from the normal stuff found in well-assorted workbench drawers such as screwdrivers and a soldering iron, the following parts are required to assemble the “product” mentioned in this document. It may be possible to order most of the parts from one single supplier — the below list contains the units which are confirmed to fit the cause, along with the name/URL of the various suppliers which they were once ordered from.

Female/female jumper wires to connect the VP2 console to the *STK500* during the development/testing stage. Adafruit.com (<http://www.adafruit.com>) product # 266 @ \$6.95. Also add female/male and male/male jumper wires, and keep them short — long wires won’t work for SPI communication.

Atmel AVR ATtiny25/45/85 microcontroller. Table 3 lists part numbers and prices. Please note that the 10 MHz versions of these MCUs have also been used with success.

DIL-8 socket with 2.54mm pin spacing such as the *TE Connectivity 1-390261-2*. Farnell (<http://www.farnell.no>) part # 1101345 @ NOK 1.11. Newark (<http://www.newark.com>) part # 52K3276 @ \$0.19.

Extension connector, 2mm/20-pos. After a minor modification, this part is extremely useful to “elevate” the expansion connector at the rear of the console — to gain easy access to the individual connectors. Digi-Key Corp. (<http://www.digi-key.com>) part # ESQT-110-02-G-D-760-ND @ \$6.28.

STK500 programmer/starter kit. Farnell (<http://www.farnell.no>) part # 3884429 @ NOK 613. Newark (<http://www.newark.com>) part # 70C6272 @ \$82.96.

BASCOM-AVR compiler/IDE for the actual programming of the *ATtiny25/45/85*. MCS Electronics (<http://www.mcselec.com>). The demo version is FREE, whereas the purchase-as-download version is just € 89.

SparkFun FTDI basic breakout, 3.3V version level converter.
SparkFun (<http://www.sparkfun.com>) product # DEV-09873 @ \$14.95.

Other level converter as appropriate, such as the *MAXIM MAX3232* series and others. There are plenty of options, but the above mentioned FTDI basic breakout remains the easiest one to hook up via USB.

6.2 Questions and answers

Are there other *attack vectors* which can be used to unlock the console serial line?

Yes. *Davis* obviously don't apply NSA security standards to their products.

Can the *ATtiny25/45/85* be removed from the console after a successful authentication?

Yes, it can. It seems that the authentication will remain valid until the console is reset. Still, please note the caution on page 2 of this document.

Can a US console be turned into a EU console?

Yes, it can — by running these commands:

```
TST 1  
BAND 1  
DOMAIN 2  
TST 0
```

...then power down or reset the console. This is probably what *Davis* does during the "burn in" stage, a process which is briefly mentioned in the *Quality Assurance Statement* enclosed with each console. The BAND/DOMAIN values can be read by issuing the same commands without the numeric arguments. Please forward valid combinations for non-US consoles to the author.

Can a *green-dot* console be downgraded to run firmware v. 1.90?

No, that simply won't work. An educated guess would be that the installed *bootloader* is a true showstopper for this approach.

Can I upgrade from firmware v. 1.90 to v. 3.12, then revert to v. 1.90 again?

Yes, provided the console is not a *green dot* unit. Consoles originally shipped with firmware version 1.90 can be upgraded to version 3.12. If, for some reason, a down-grade is desired, simply run the v. 1.90 installer to re-install the "old" firmware version.

Any news regarding the calculation of security register values?

Yes. On November 28, 2013 *WForum.net* user *watson* published the algorithm to calculate the security register values based on a known device ID. Section 4.4 refers.

What would be the right thing for *Davis* to do regarding firmware v. 3.xx?

To openly admit that the "original data logger requirement" is a failure, only damaging the company's reputation — followed by an immediate release of a new firmware version which does not block the serial line or otherwise cripple the console unit.

In general, what would be the right thing to do for *Davis*?

Open up! Proprietary software and proprietary hardware are things of the past. Publish the ISS data transmission protocol and allow for people to experiment. Appreciate the fact that your customers find new ways to make use of your products. Lower the MSRPs, you'll still make a nice profit and even attract new customers.

How should a company make use of social media?

Almost any way they like, *except* by exercising total censorship and ignoring customer feedback and criticism. Work *with* your customers, not *against* them. Your customers are the only reason you're in business. Appreciate that your customers like your product so much that they expand on it — which only confirms that the initial product design was a good one. And ... *never, ever* lie to your customers.

What does it take to get banned from the *Davis Instruments Weather Facebook* page?

Posting two critical questions, none of which were ever answered. You'd better be careful.

What if new firmware versions will contain a security register blacklist?

That's a risk, but why would *Davis* accept even more negative PR by blocking legitimate security register values? Such an action would only imply that someone owning an original *Davis green dot* data logger would end up with a useless unit.

Also, upgrading to the latest firmware version is by no means a requirement. Finally, the limited amount of memory available in the *ATmega128L* MCU is better used for other purposes than maintaining a list of security register values which have been widely distributed.

What does it take to build a third-party data logger?

A little effort. Study the datasheets for the relevant components and you'll find that bits and pieces fit together quite nicely. Or use a *Raspberry Pi*, a *BeagleBone* or another minicomputer which can be configured to meet your exact needs.

What's the main purpose of this document?

Self-education. And, of course, to aid others in obtaining access to the serial line on their crippled *Davis* console — without spending \$165 on a data logger which will only cause erroneous indoor temperature readings.

Also — hopefully — someone at *Davis* will realize how *one* single management decision aids in tearing apart the company's reputation.

Where can I get a pre-programmed *ATtiny25/45/85* as described in this document?

Get in touch with the author, who may have some at hand for \$25, including worldwide airmail shipping. Payments are accepted via *PayPal*. Please note the previous question, though — this is not a business undertaking¹⁴, only "users helping users".

Please specify whether you prefer the "fixed ID" (section 4.3) or the "random ID" (section 4.4) variant. Also note that all in-house tests of the "random ID" variant have been successful — still there is no *guarantee* that all permutations generated will authenticate with the VP2/Vue consoles. If authentication fails, simply remove all power from the console and try again.

Can the serial line be used for a firmware upgrade?

Yes, that's indeed one of the purposes of the serial line. Several consoles have been upgraded from firmware version 1.90 to version 3.12 and from version 3.00 to version 3.12. You only need the GND, TXD and RXD lines. No data logger is required, as long as the serial line has been unlocked.

¹⁴The author already has a daytime job — and he is not running a charity, so if you don't want to go through the process of programming the *ATtiny25/45/85* yourself, you can pay a few dollars for the parts, shipping and trouble caused. That's just fair, isn't it?

Why won't *WeatherLink* work with just the serial line?

Because *WeatherLink* is old-school proprietary software and even requires a hardware-provided communication handshake, achieved by:

- Connecting the RTS and CTS lines.
- Connecting the DSR, DTR and (D)CD lines.

Figure 20 and the excellent writeup by *DeKay* [11] refer. Oh, BTW, the entire concept of a hardware-implemented communication handshake in the data logger is *so* 1980-ish.

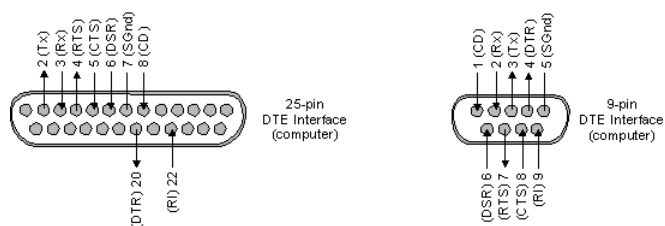

Figure 20: Data Terminal Equipment (DTE) pin numbering for the 25-pin and 9-pin connectors normally used for serial-line communications. In other words, the above pin numbers appear "as seen" when looking directly at a PC-side COM port.

Credits?

Thanks to *WXForum.net* users *DeKay*, *rdsman*, *belfryboy*, *iBangkok24*, *franzz*, *watson* and *kashima* for sharing their excellent work.

6.3 Contact information

Contact information, web address, Google Groups discussion forum, et cetera:

Torkel M. Jodalen
Pb. 1036 Jeløy
NO-1510 Moss
Norway

Email → tmj@bitwrap.no (no technical questions, please)

Web → <http://meteo.annoyingdesigns.com>

WOSP*i* → [http://meteo.annoyingdesigns.com/WOSP*i*.pdf](http://meteo.annoyingdesigns.com/WOSP<i>i</i>.pdf)

Social media — for those of us banned from *Davis'* official *Facebook* page
→ <https://www.facebook.com/DavisWeather>

Google Groups → [https://groups.google.com/group/wosp*i*?hl=en](https://groups.google.com/group/wosp<i>i</i>?hl=en)
(Yes, we're using the WOSP*i* group for this purpose, too — feel free to post your technical questions here).

Remember → Always have the appropriate amount of fun.

References

- [1] Davis Instruments Corp. *Davis Instruments 2013 Catalog*. Hayward, CA, USA, 2013.
- [2] Davis Instruments Corp. *Vantage Pro, Vantage Pro2 and Vantage Vue serial communication reference manual v. 2.61*. http://www.davisnet.com/support/weather/download/VantageSerialProtocolDocs_v261.pdf, 2013. Accessed: 2013-06-22.
- [3] Atmel Corporation. *STK500 User Guide*. <http://www.atmel.com/Images/doc1925.pdf>, 2003. Accessed: 2013-06-29.
- [4] Atmel Corporation. *AVR319: Using the USI module for SPI communication*. <http://www.atmel.com/Images/doc2582.pdf>, 2004. Accessed: 2013-06-27.
- [5] Atmel Corporation. *8-bit Atmel microcontroller with 128kbytes in-system programmable flash*. <http://www.atmel.com/Images/doc2467.pdf>, 2011. Accessed: 2013-06-22.
- [6] Atmel Corporation. *The AVR STK500 Starter Kit*. <http://www.atmel.com/tools/STK500.aspx>, 2012. Accessed: 2013-06-27.
- [7] Atmel Corporation. *Atmel Studio 6*. http://www.atmel.com/microsite/atmel_studio6/, 2013. Accessed: 2013-06-27.
- [8] Atmel Corporation. *ATtiny25/45/85 datasheet*. <http://www.atmel.com/devices/ATTINY25.aspx?tab=documents>, 2013. Accessed: 2013-06-28.
- [9] crun@users.sourceforge.net. *Serial Terminal: RealTerm*. <http://realterm.sourceforge.net>, v. 2.0.0.70. Accessed: 2013-06-28.
- [10] DeKay. *It's science, but it works like magic (blog)*. <http://madscientistlabs.blogspot.no>, 2012. Accessed: 2013-06-22.
- [11] DeKay. *Make your DIY Davis datalogger work with Weatherlink*. <http://madscientistlabs.blogspot.no/2012/02/make-your-diy-davis-datalogger-work.html>, 2012. Accessed: 2013-07-10.
- [12] MCS Electronics. *The BASCOM-AVR compiler*. http://www.mcselec.com/?option=com_content&task=view&id=14&Itemid=41, 2012. Accessed: 2013-06-27.
- [13] The Raspberry Pi Foundation. *The Raspberry Pi*. <http://www.raspberrypi.org>, 2012. Accessed: 2013-06-22.
- [14] Torkel M. Jodalen. *A Weather Observation System for the Raspberry Pi*. http://meteo.annoyingdesigns.com/WOSP_i.pdf, 2012. Accessed: 2013-06-30.

- [15] Saleae LLC. The Logic16 logic analyser. <http://www.saleae.com/logic16>, 2013. Accessed: 2013-06-24.
- [16] Jurij Mikeln. *Introduction to microcontroller programming using BASCOM*. AX elektronika d.o.o., Ljubljana, Slovenia, 2000.
- [17] Jurij Mikeln and Vladimir Mitrovic. *BASCOM AVR programming*. AX elektronika d.o.o., Ljubljana, Slovenia, 2012.
- [18] Where Labs LLC / Dangerous Prototypes. BusPirate v3. http://dangerousprototypes.com/docs/Bus_Pirate, 2013. Accessed: 2013-06-24.
- [19] rdsman. DIY Green Dot Data Logger. <http://www.wxforum.net/index.php?topic=18110.msg176884#msg176884>, 2013. Accessed: 2013-06-30.
- [20] Adesto Technologies. AT45DB011 DataFlash. <http://adestotech.com/sites/default/files/datasheets/doc3639.pdf>, 2012. Accessed: 2013-06-24.
- [21] watson. DIY "GREEN DOT" Data Logger. <http://www.wxforum.net/index.php?topic=18110.msg200376#msg200376>, 2013. Accessed: 2013-11-28.
- [22] Wikipedia. Dual in-line package. http://en.wikipedia.org/wiki/Dual_in-line_package, 2013. Accessed: 2013-06-30.
- [23] Wikipedia. The Serial Peripheral Interface. http://en.wikipedia.org/wiki/Serial_Peripheral_Interface_Bus, 2013. Accessed: 2013-06-24.
- [24] WinAVR. <http://winavr.sourceforge.net>, 2013. Accessed: 2013-06-27.

Revision history

A working implementation using the *ATtiny25/45/85* series of MCUs was complete as of December, 2012. Writing the documentation/do-it-yourself-guide is what has taken most of the time.

The revision history of this document is recorded below.

Date	Change(s) applied
2014.07.01	Minor editorial changes.
2013.11.30	Added section 4.4.
	Editorial changes.
2013.11.28	Minor editorial changes.
2013.11.03	Minor editorial changes.
2013.10.28	Minor change to the program code.
2013.10.16	Minor editorial changes.
2013.08.06	Minor editorial changes.
	Added wiring diagram.
2013.07.31	Minor editorial changes.
2013.07.30	Minor editorial changes.
2013.07.29	Minor editorial changes.
2013.07.28	Minor editorial changes.
2013.07.27	Corrected error in wiring diagram.
2013.07.22	Minor editorial changes.
2013.07.18	Minor editorial changes.
2013.07.15	Added product description: SparkFun FTDI basic breakout.
	Minor editorial changes.
2013.07.11	Minor editorial changes.
2013.07.10	Minor editorial changes.
2013.07.07	Minor editorial changes.
2013.07.06	Minor editorial changes and corrections.
2013.07.01	Initial public release.

